



Please consult the manufacturer's installation manual for all details and requirements before making a final design layout decision.

TRUE
42" Direct Vent Gas Fireplace

MODEL	FRONT WIDTH		BACK WIDTH		HEIGHT		DEPTH		GLASS SIZE
	Actual	Framing	Actual	Framing	Actual	Framing	Actual	Framing	
TRUE-42	67	65-9/16	65-5/16	65-9/16	62-5/8	61	24	24	41-7/8 x 36-1/16

UNIT

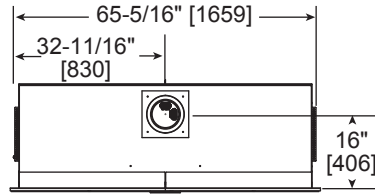

Top

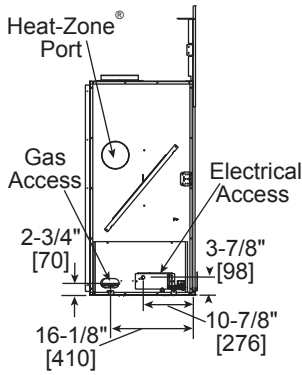

Left

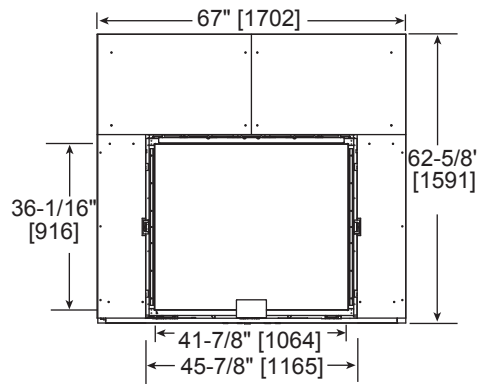

Front

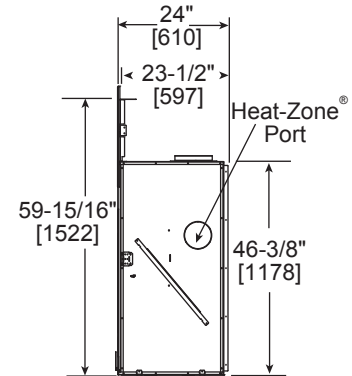

Right

FRONTS

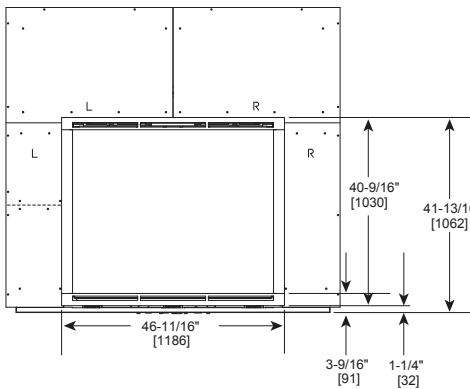

Firescreen

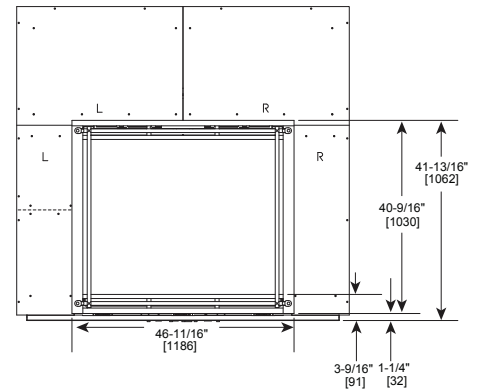

Forge

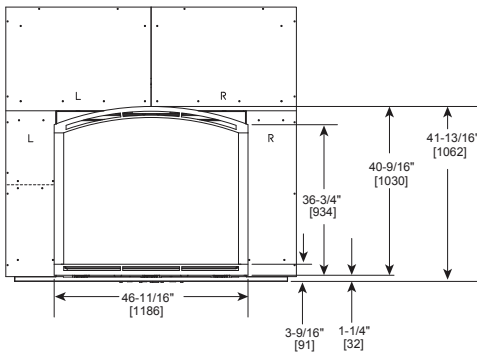

Arched
Firescreen

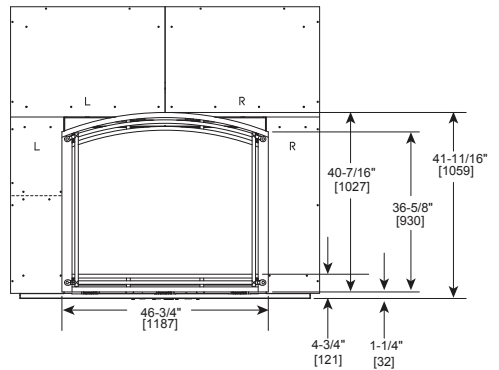

Arched
Forge

APPLIANCE LOCATION

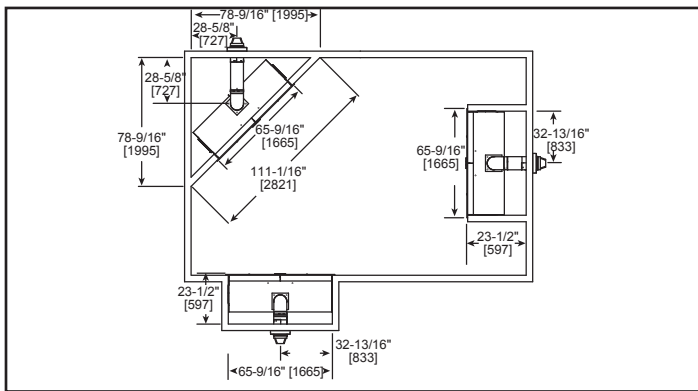

WALL PENETRATION

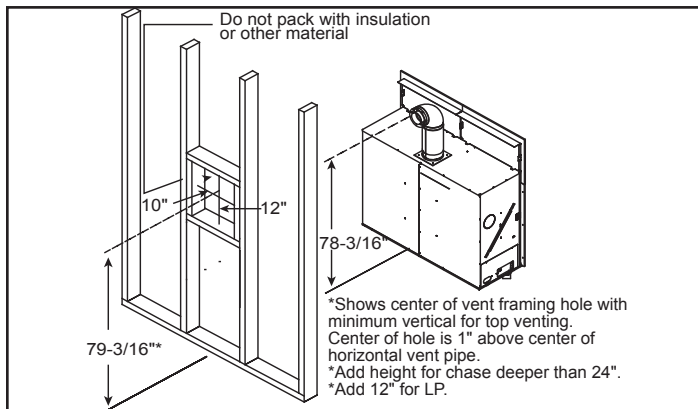

MANTEL LEG/WALL PROJECTIONS

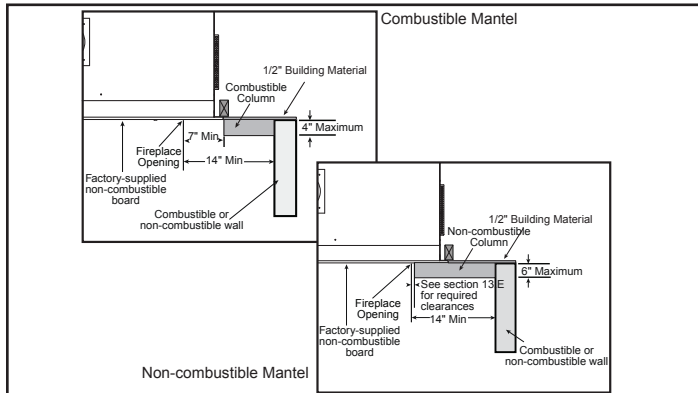

COMBUSTIBLE MANTEL PROJECTIONS

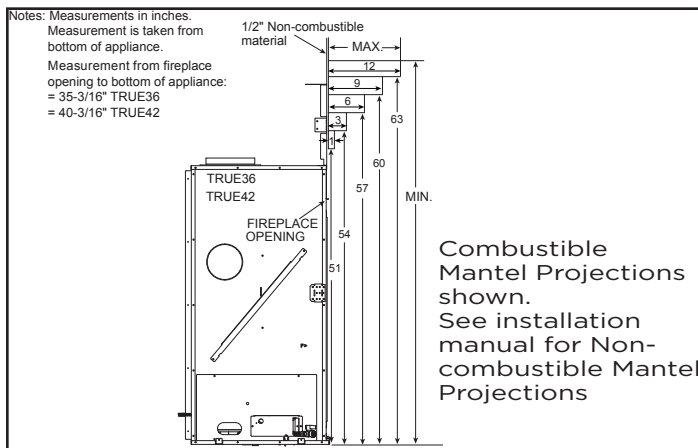

FRAMING DIMENSION

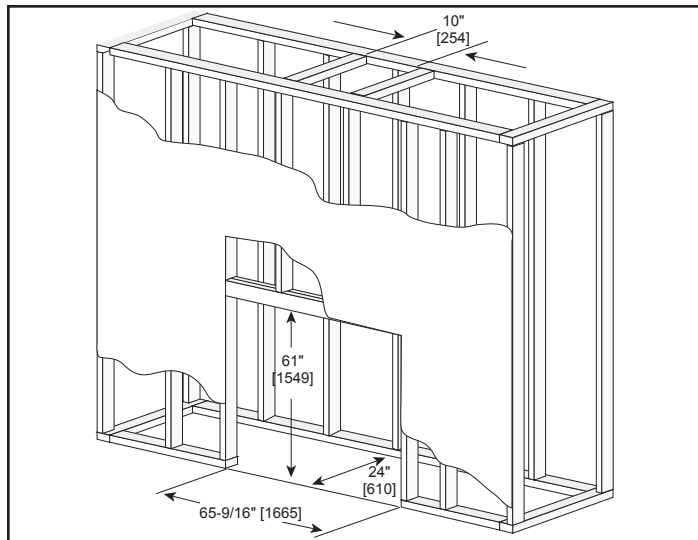

CLEARANCES TO COMBUSTIBLES

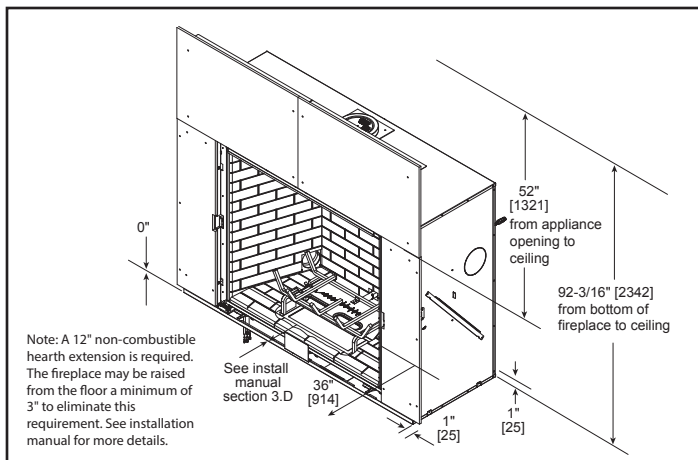

NON-COMBUSTIBLE ZONE

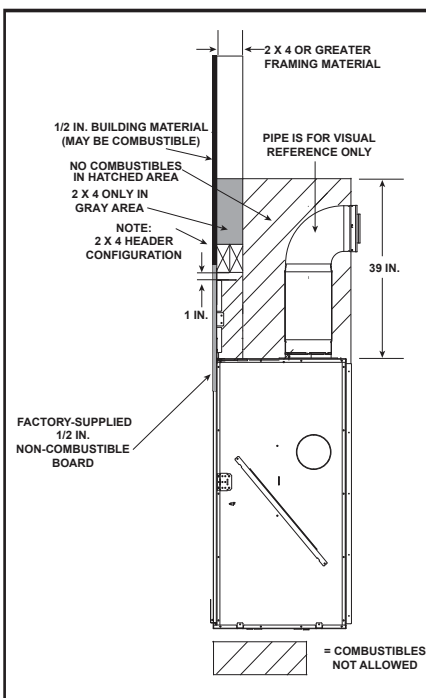

PRODUCT LISTING CODES	
US	ANSI Z21.88-2014
CAN	CSA 2.33-2014
	UL307B

Product information provided is not complete and is subject to change without notice. Product installation must adhere strictly to instructions accompanying product to avoid risk of fire and potential injury.

Additional information can be found online at www.heatnglo.com